



SHORT INSTALLATION MANUAL

Metrotile[®]
worldwide roofing systems

METROTILE® TILES

Bond



Length of Tile: 1330 mm
Length of Cover: 1270 mm
Width of Cover: 371 mm
Tiles/m²: 2.13
Minimum Pitch: 10° (18%)

Classic



Length of Tile: 1330 mm
Length of Cover: 1265 mm
Width of Cover: 369 mm
Tiles/m²: 2.14
Minimum Pitch: 10° (18%)

Gallo



Length of Tile: 1320 mm
Length of Cover: 1190 mm
Width of Cover: 368 mm
Tiles/m²: 2.28
Minimum Pitch: 10° (18%)

Mistral



Length of Tile: 1305 mm
Length of Cover: 1240 mm
Width of Cover: 367 mm
Tiles/m²: 2.18
Minimum Pitch: 10° (18%)

Roman



Length of Tile: 1280 mm
Length of Cover: 1220 mm
Width of Cover: 368 mm
Tiles/m²: 2.23
Minimum Pitch: 10° (18%)

METROTILE® TILES

Romana



Length of Tile: 1165 mm
Length of Cover: 1085 mm
Width of Cover: 368 mm
Tiles/m²: 2.5
Minimum Pitch: 15° (27%)

Woodshake



Length of Tile: 1340 mm
Length of Cover: 1262 mm
Width of Cover: 369 mm
Tiles/m²: 2.15
Minimum Pitch: 10° (18%)

Shake



Length of Tile: 1330 mm
Length of Cover: 1265 mm
Width of Cover: 368 mm
Tiles/m²: 2.15
Minimum Pitch: 10° (18%)

Viksen

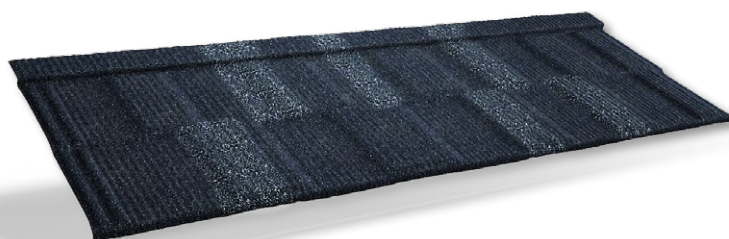

Length of Tile: 1340 mm
Length of Cover: 1260 mm
Width of Cover: 368 mm
Tiles/m²: 2.16
Minimum Pitch: 10° (18%)

UNDERLAY AND BATTENS

STORAGE AND HANDLING

If storage outside, a waterproof cover must be placed over the tiles to keep them dry and prevent damage to the substrate.

NON-STANDARD ELEMENTS

Materials that could cause corrosion (e.g. copper, lead, stainless steel) should not be used above the level of the roof.

ROOF TRAFFIC

Weight should be placed directly over the batten in pans of tile when walking on the roof.

CUTTING WITH A SAW

When cutting tiles with a metal cutting saw (which has been approved by IKO Metals), special (tipped) metal cutting blades should be used. Cutting should be performed with the chip-coated surface facing downwards to reduce the amount of swarf adhering to the chip coating. Failure to do so will result in rust stains on the tile surface.

WET SURFACE

Walking and working on a wet roof should not be attempted.

BATTENS

Recommended counter batten dimension is 50 x 80 mm.
Tile batten size is 40 x 50 mm (distance between rafters less than 900 mm).

LOCAL STANDARDS

It is strongly recommended that local building standards and regulations are always followed and fully complied with.

HANDLING

Care should be taken when handling the tiles to avoid damage to the surface. If minor damage does occur, the Repair kit should be used to repair it.

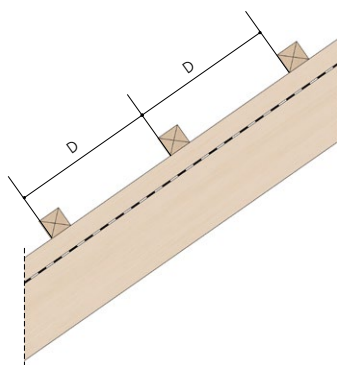

Name of the profile	Batten Space (D)
Bond Tile	371 mm
Classic Tile	369 mm
Gallo Tile	368 mm
Mistral Tile	367 mm
Roman Tile	368 mm
Romana Tile	368 mm
Woodshake Tile	369 mm
Shake Tile	368 mm
Viksen Tile *	368 mm

* Battening for Viksen requires the use of intermediate battens (refer to Batten Space for Viksen Tile).

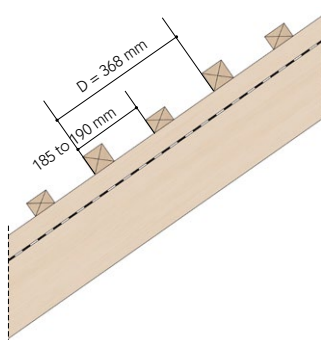

UNDERLAY AND BATTENS

RIDGE BATTEN



GABLE



HIP BATTEN

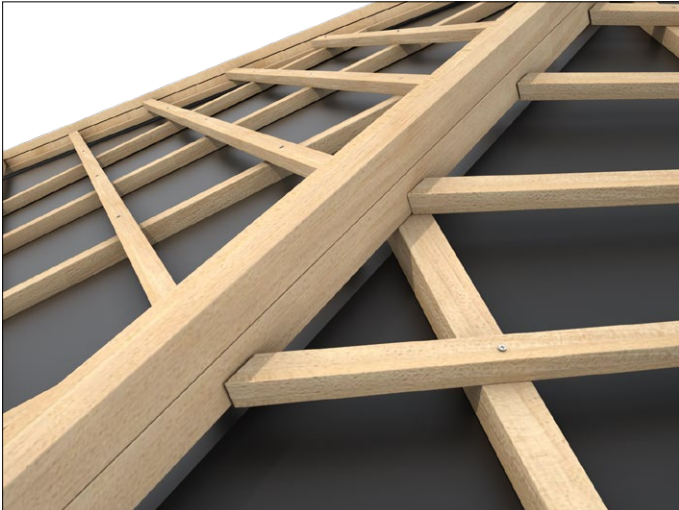

EAVE



VALLEY

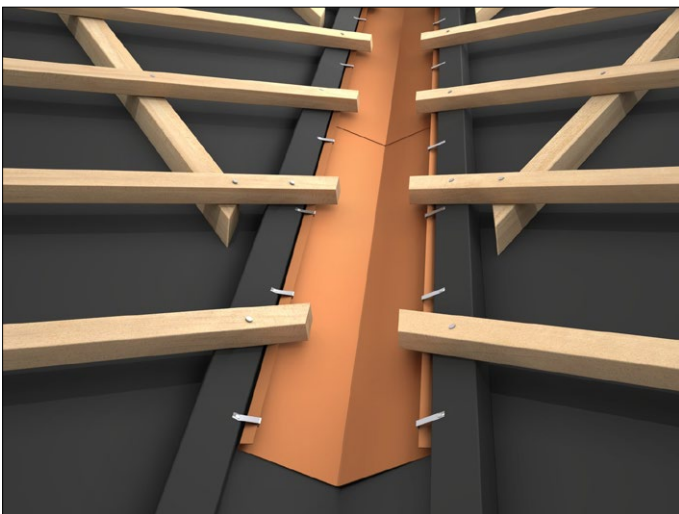

Option 1

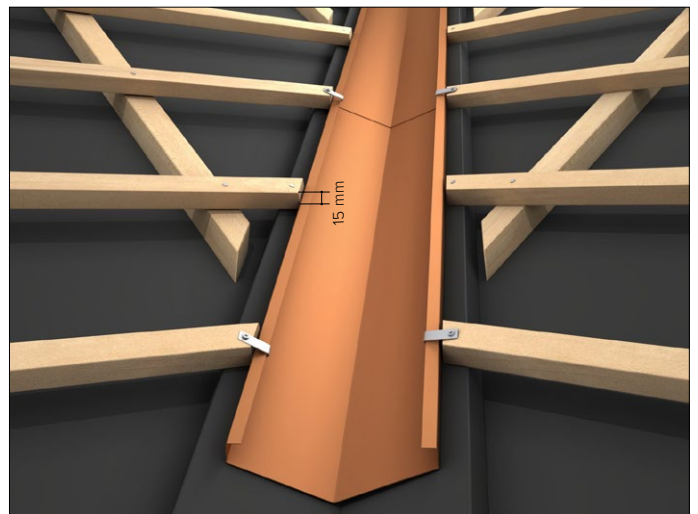

Option 2

INTERLOCKING OF THE TILES

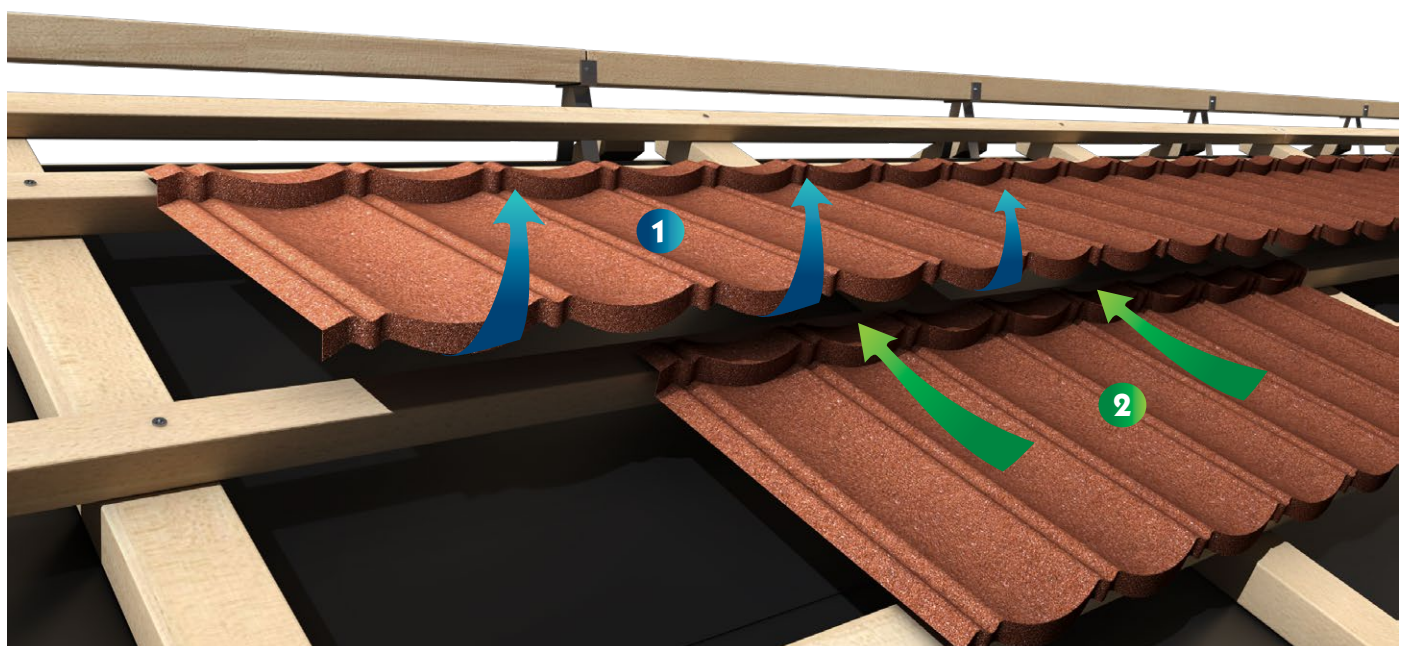
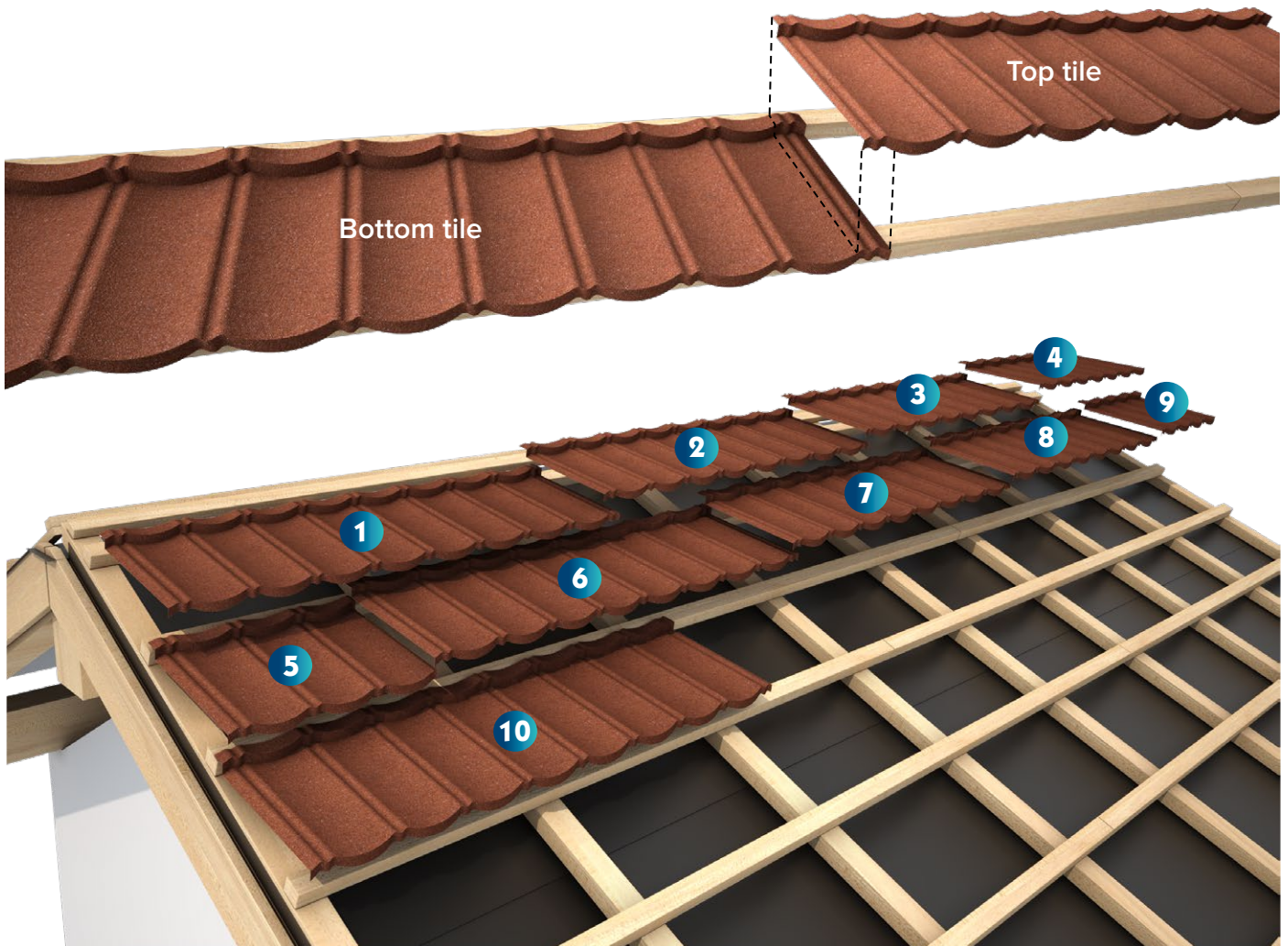

NAIL POSITIONING

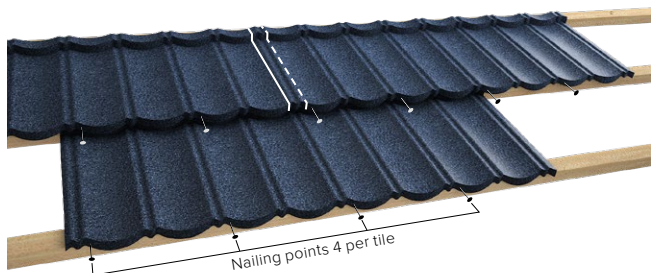

METROTILE BOND

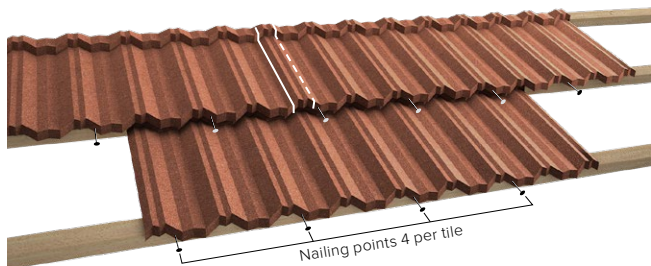
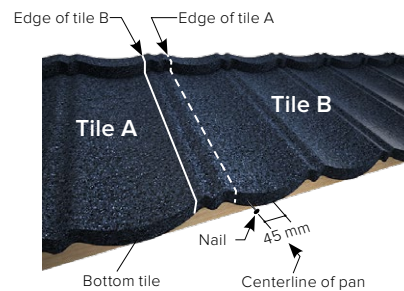
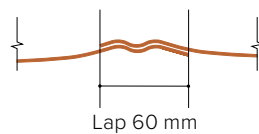

METROTILE CLASSIC

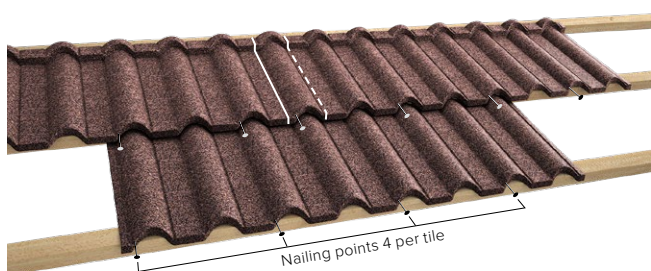
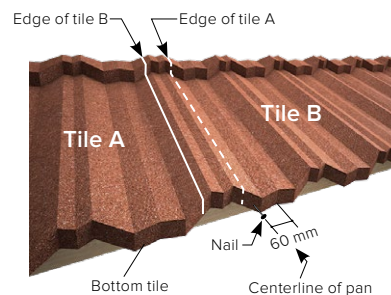
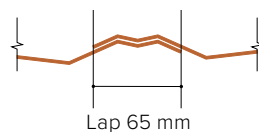

METROTILE GALLO

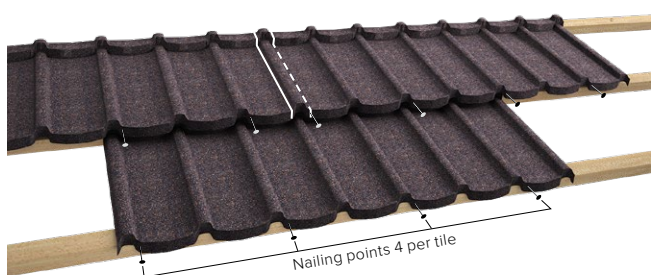
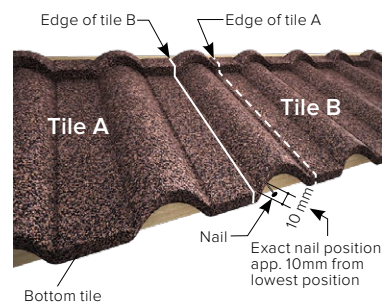
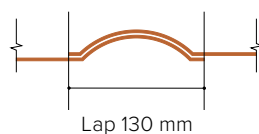

METROTILE MISTRAL

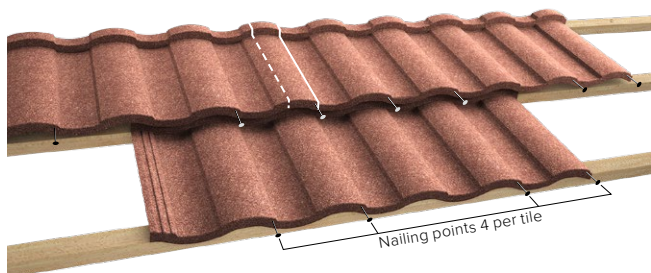
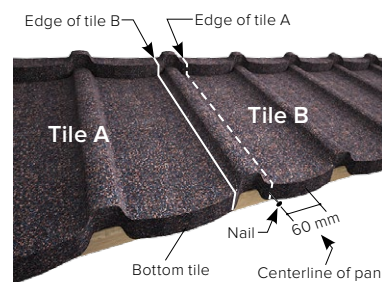
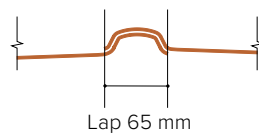

METROTILE ROMAN

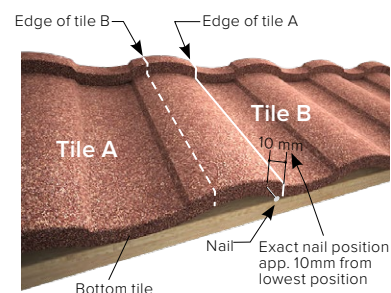
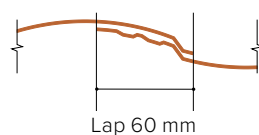

NAIL POSITIONING

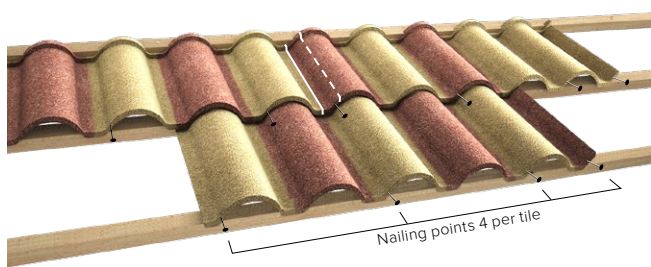

METROTILE ROMANA

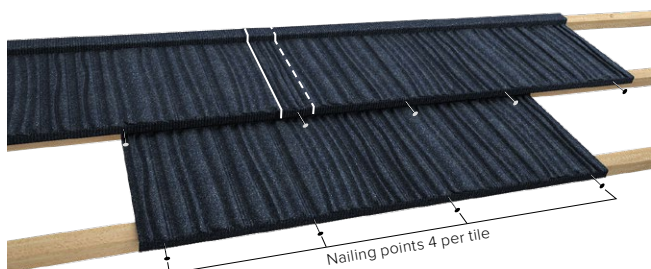
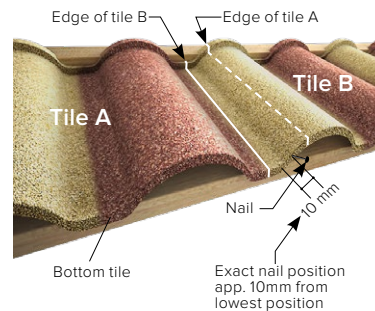
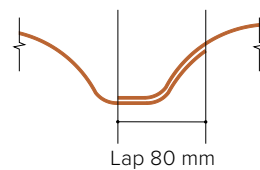

METROTILE WOODSHAKE

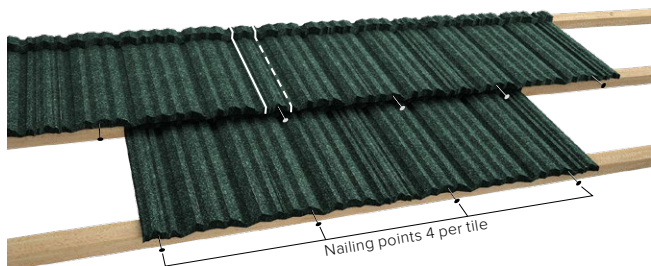
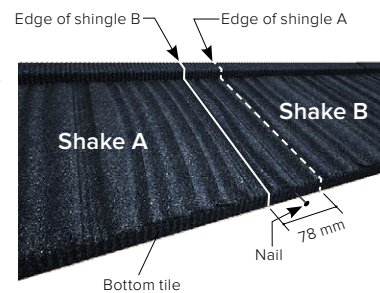
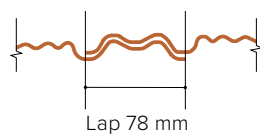

METROTILE SHAKE

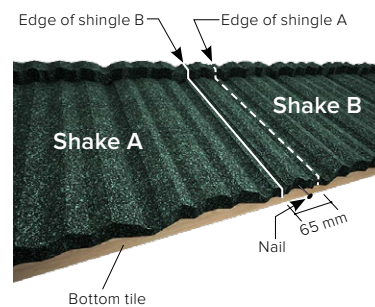
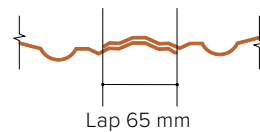

Shake allows to be staggered only in two positions. Parallel laying is not possible.

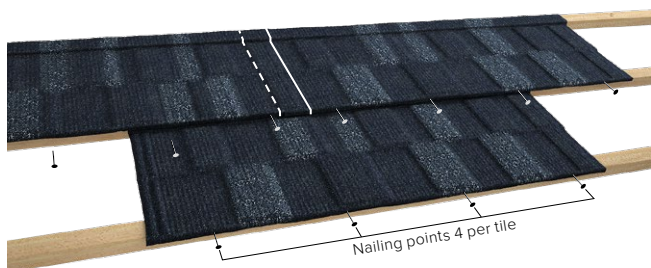

METROTILE VIKSEN

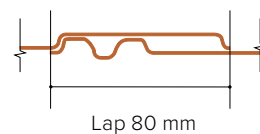

INSTALLATION DETAILS

EAVE APRON

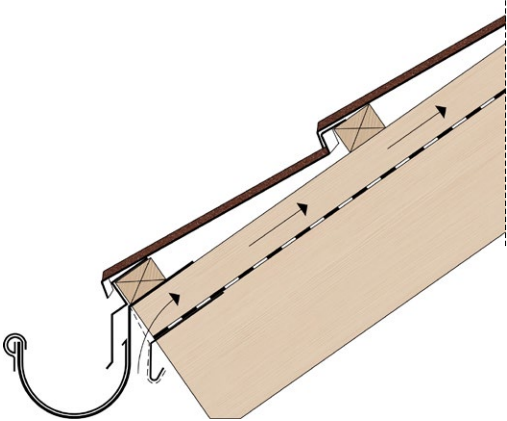

RIDGE INSTALLATION

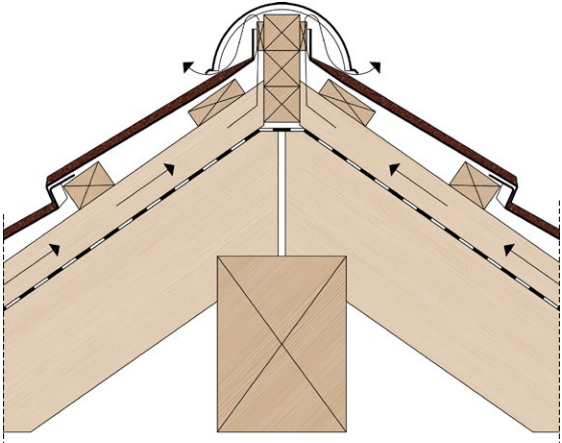
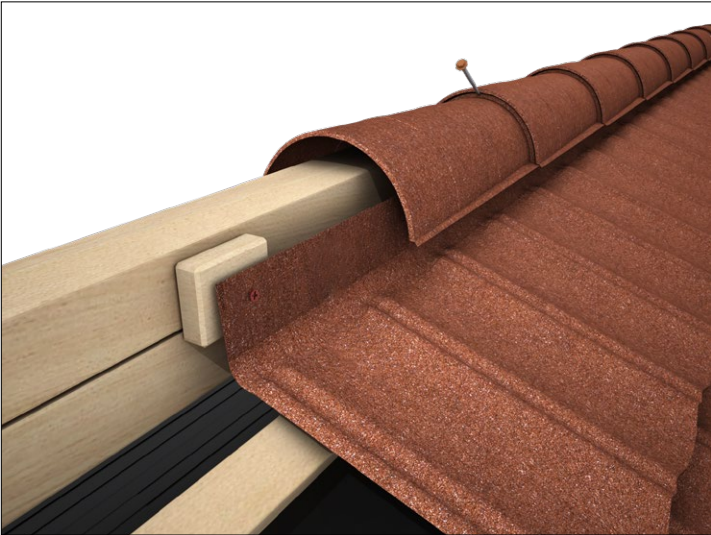

HIP INSTALLATION

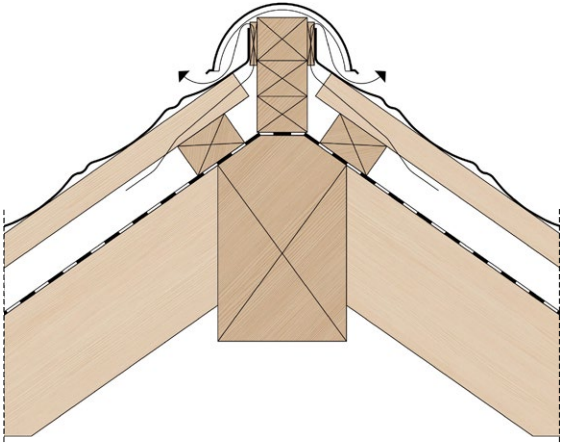

INSTALLATION DETAILS

BARGE INSTALLATION

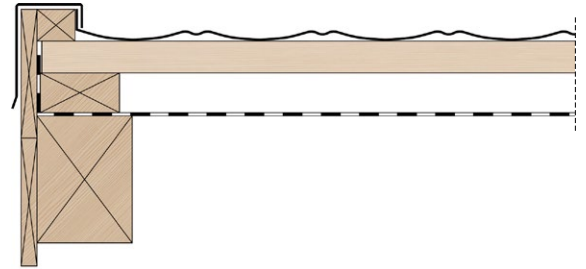

VALLEY INSTALLATION

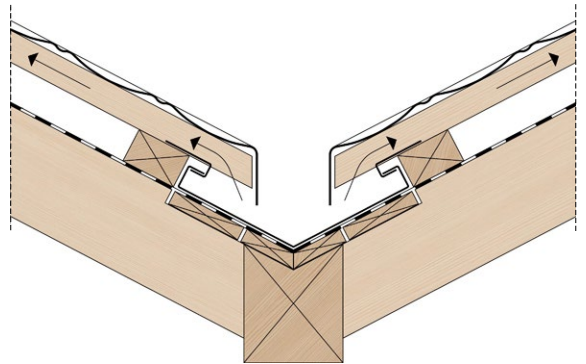

WALL FLASHING

